

EPDM Profile

Endlos extrudierte Profile aus EPDM können als Hohlkammer-, Schlauch-, Massivgummi- oder Moosgummiprofile hergestellt werden.



Kremer liefert Profile u.a. in folgende Branchen:

- Tür-, Fenster- und Fassadenbau
- Wintergarten- und Gewächshausbau
- Erneuerbare Energien
- Fahrzeug- und Nutzfahrzeugbau

Kremer
Technology

an **ERIKS** company

KREMER Technology GmbH • Kinzigstraße 9 • 63607 Wächtersbach

TEL 06053/6161-0 • FAX 06053/9739 • MAIL info@kremer-tec.de

www.kremer-tec.de

EPDM Profile



Der **Gradmesser für die Qualität** eines Dichtungsprofils im **Tür-, Fenster- und Fassadenbau** wird einzig und alleine durch die Witterungsbeständigkeit bestimmt. Kälte, Hitze, Feuchtigkeit, Ozon und Sonnenlicht dürfen die Funktionalität nicht beeinträchtigen.

Unsere **Spezial-EPDM-Werkstoffe** für die Herstellung unserer Profile in den Härteklassen 50 bis 90 Shore A entsprechen der **DIN 7863-1-Tabelle 2 und 3**. Wir liefern Profile mit **Toleranzen** nach DIN 3302-1 **E2** und je nach Bedarf oder technischer Erfordernisse gegebenenfalls auch nach DIN 3302-1 **E1**.

Unser Lieferprogramm von EPDM-Profilen beinhaltet:

MOOSGUMMIPROFILE PROFILRAHMEN
RUNDSCHNÜRE
VIERKANTPROFILE
VIERKANTPROFILE
WEICHGUMMIPROFILE
MOOSGUMMIPROFILE
RUNDSCHNÜRE
WEICHGUMMIPROFILE
PROFILRAHMEN

Auf den nachfolgenden Seiten sehen Sie eine Auswahl von Profilquerschnitten von mittlerweile **über 3.000 kundenspezifischen Dichtungsprofilen**.

EPDM Profile



EPDM Profile

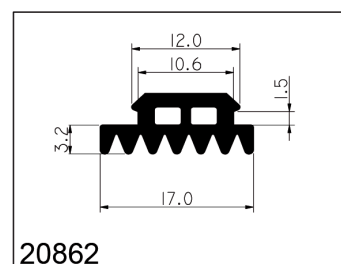
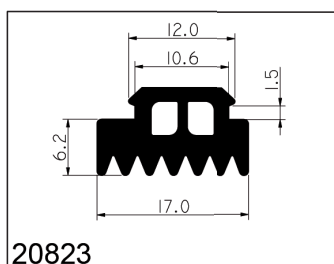
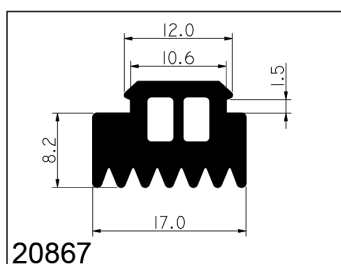
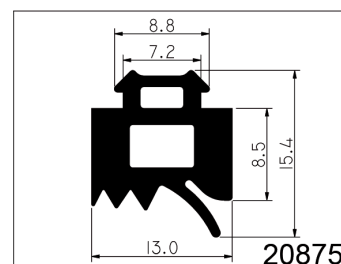
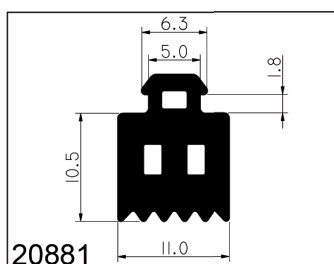
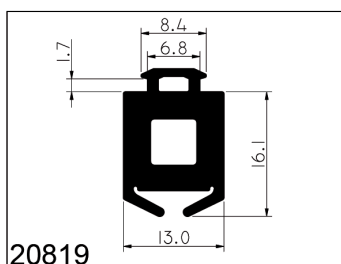
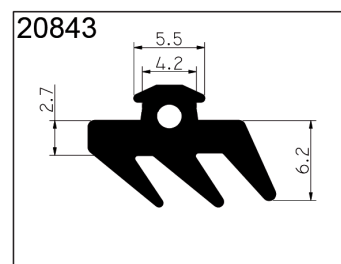
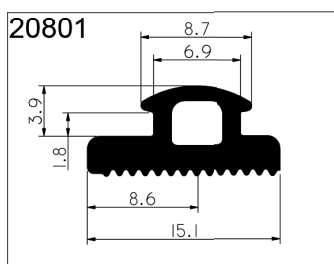
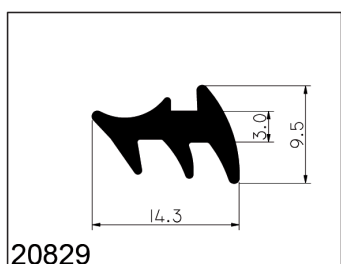
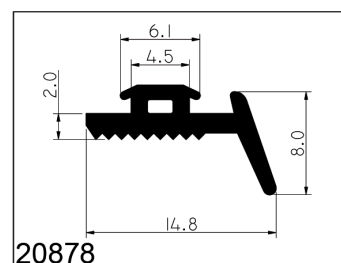
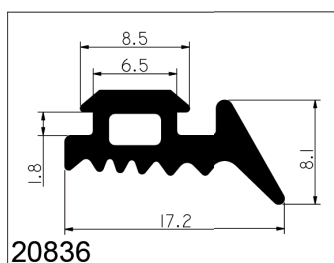
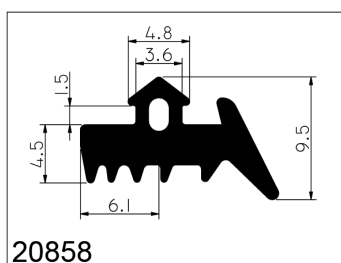
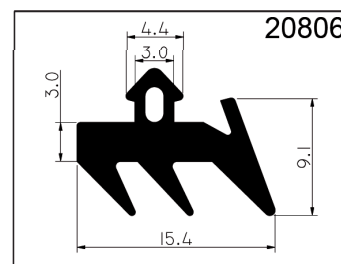
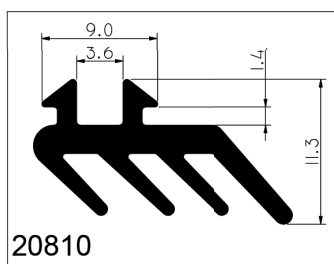
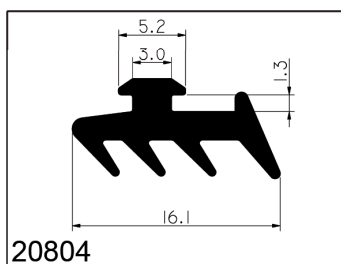
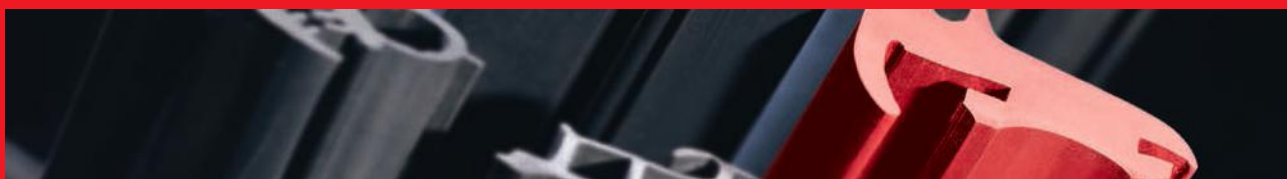

EPDM Profile

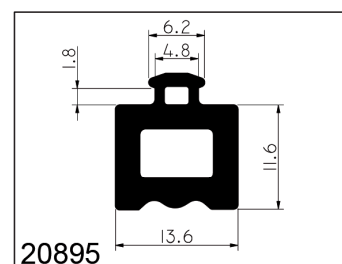
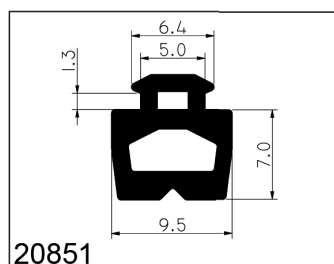
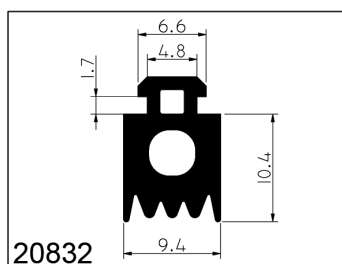
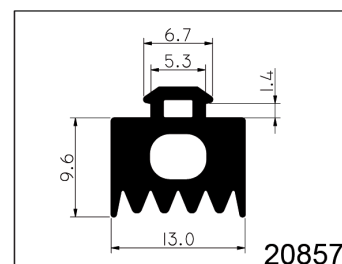
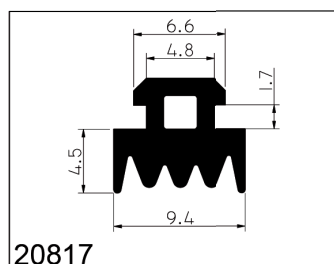
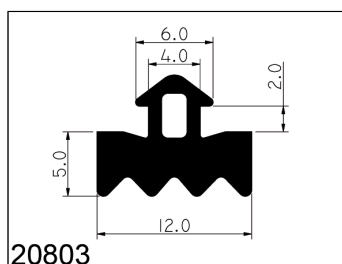
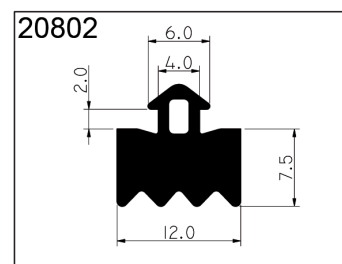
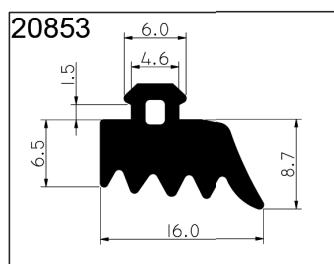
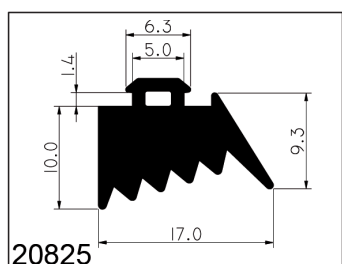
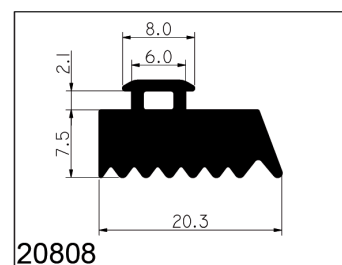
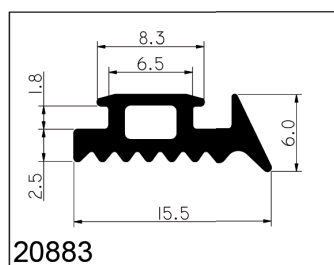
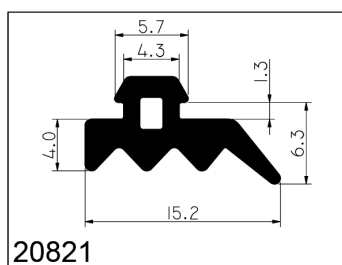
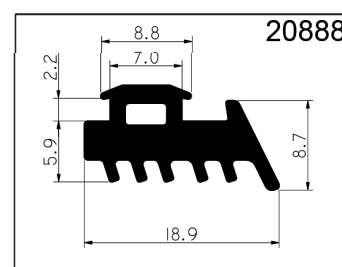
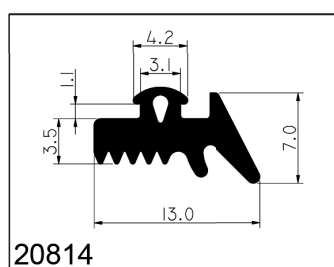
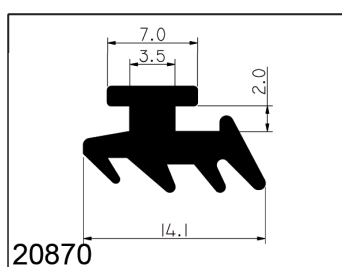

EPDM Profile

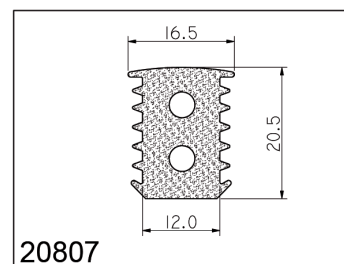
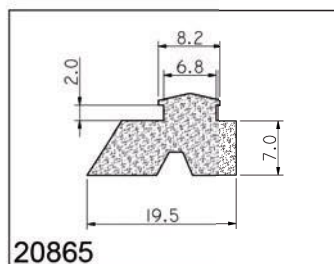
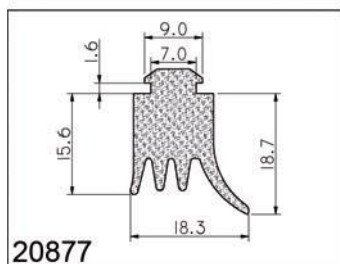
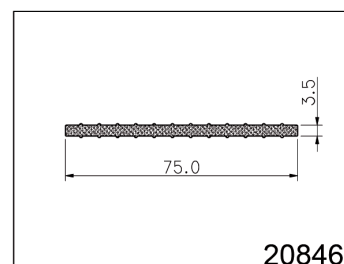
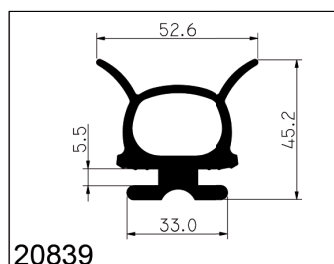
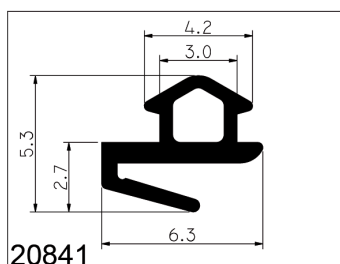
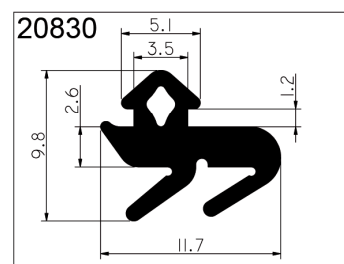
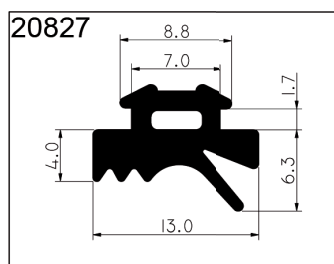
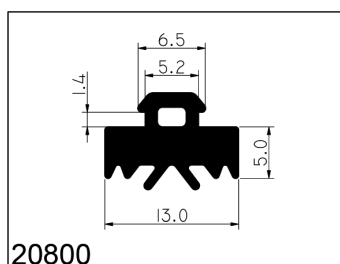
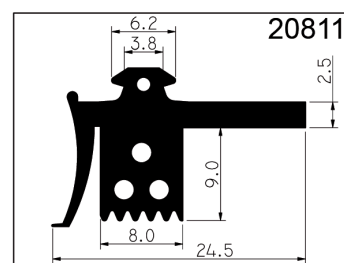
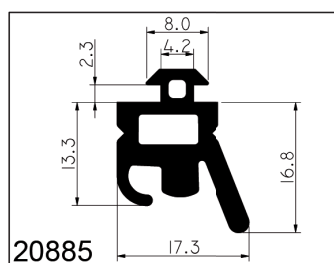
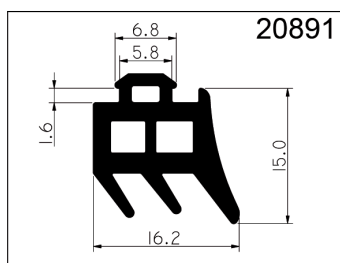
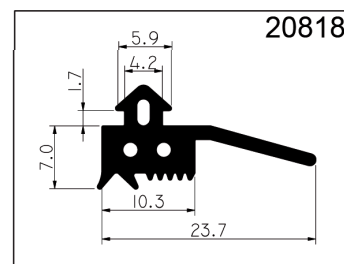
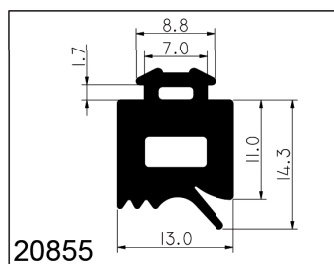
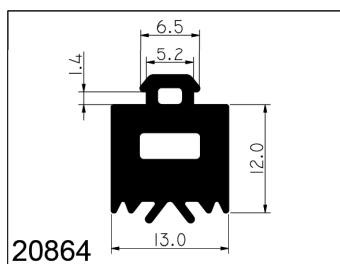

EPDM Profile

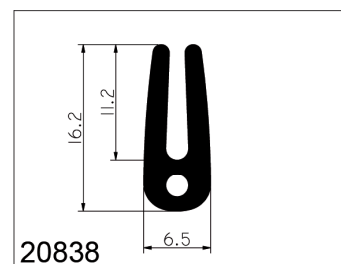
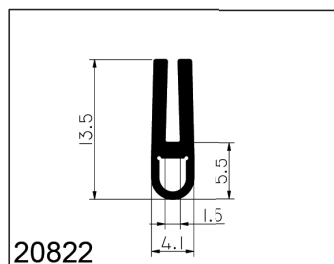
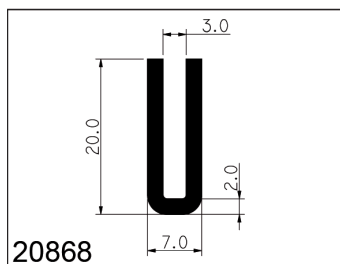
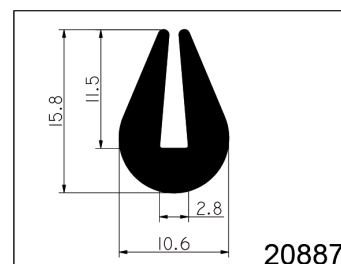
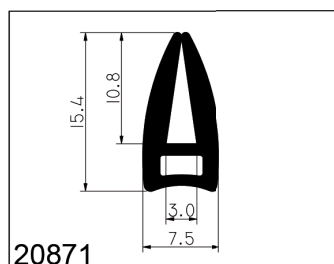
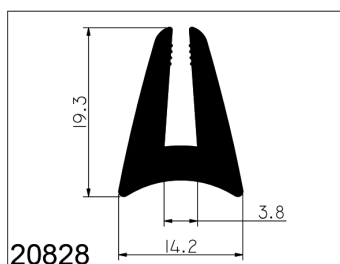
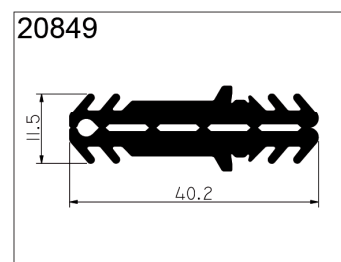
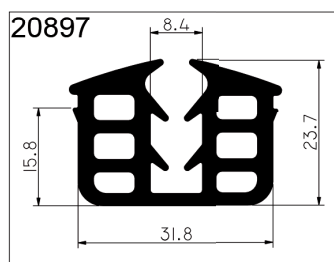
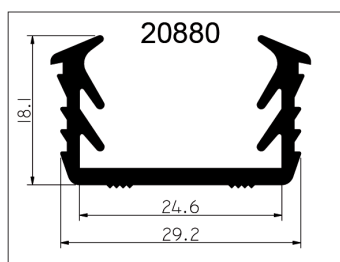
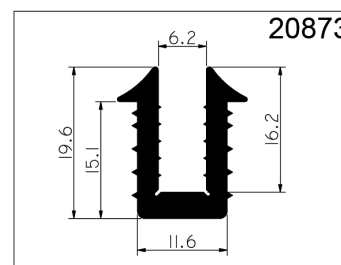
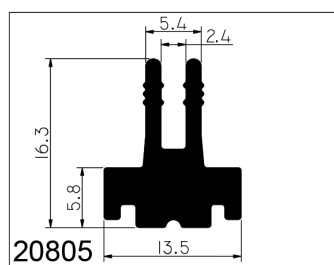
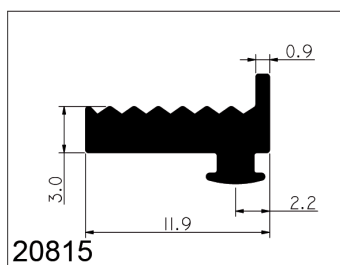
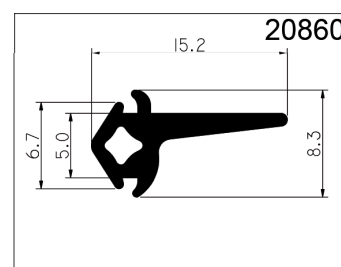
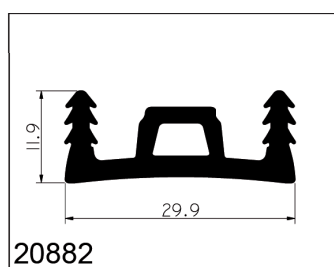
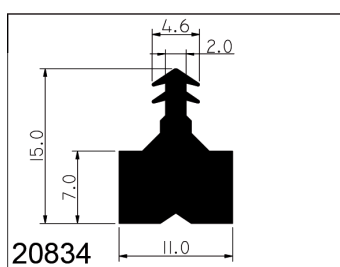
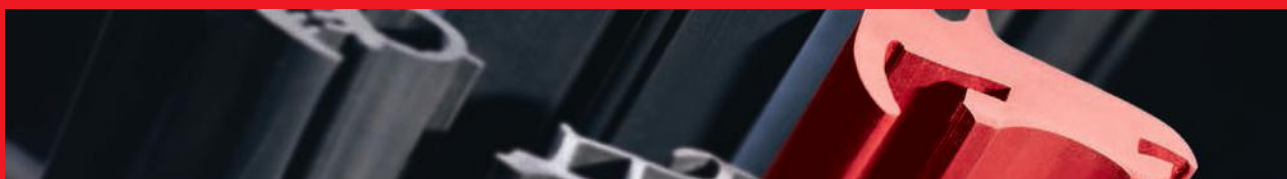

EPDM Profile

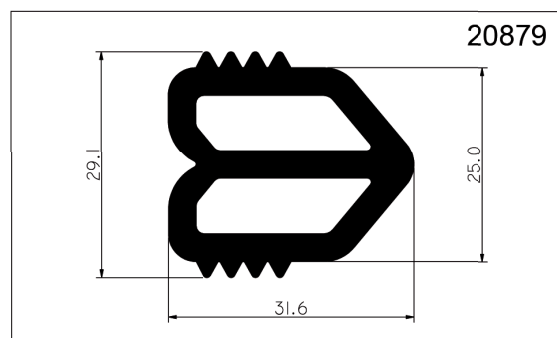
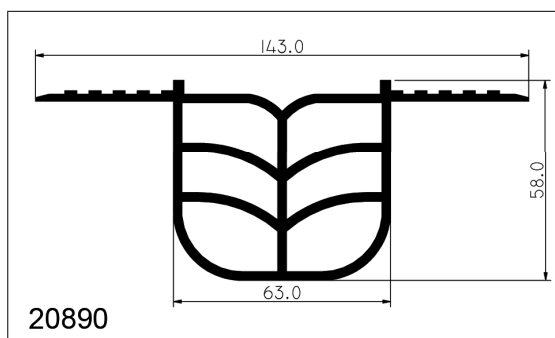
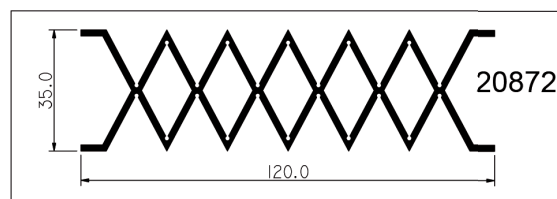
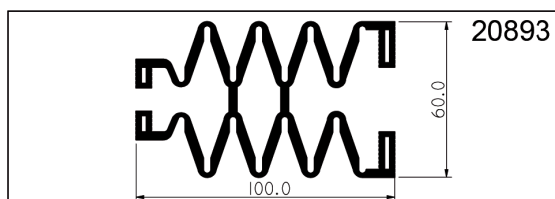
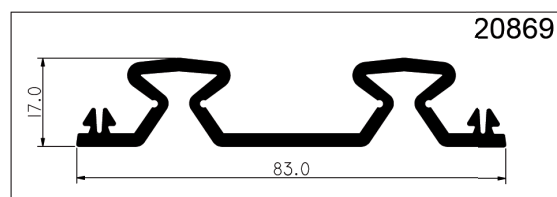
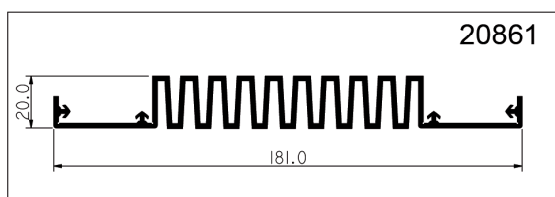
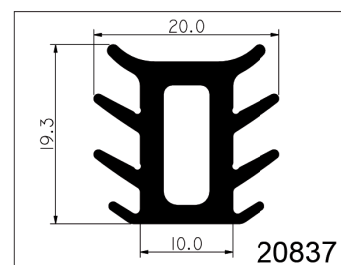
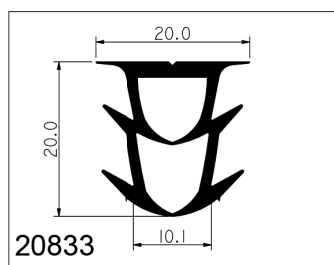
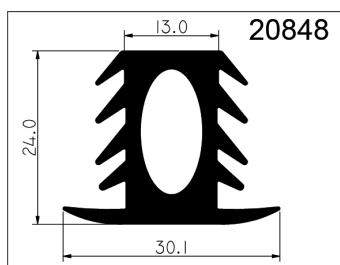
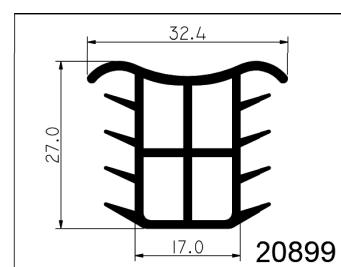
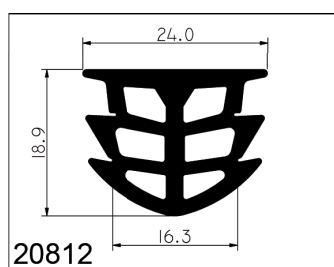
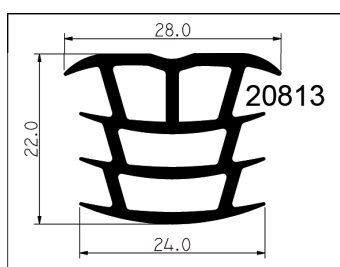
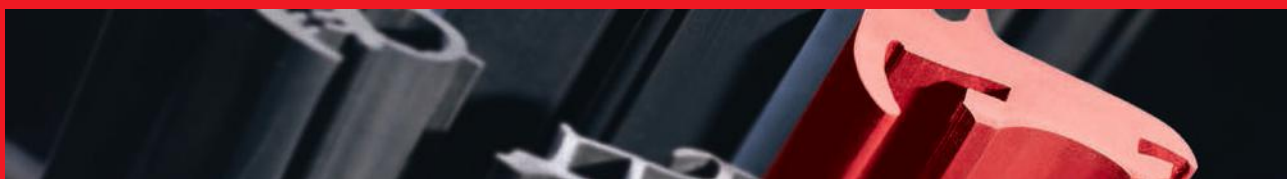

EPDM Profilelecken

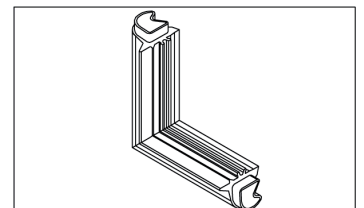
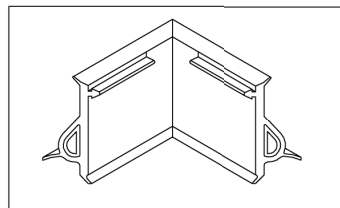
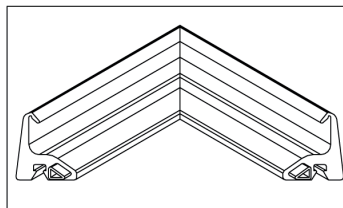
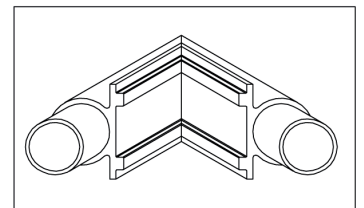
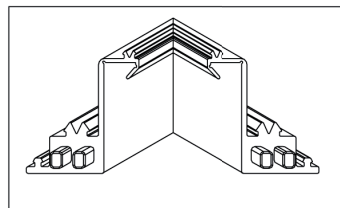
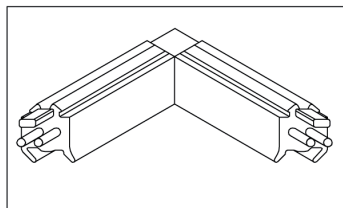
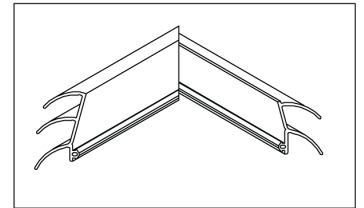
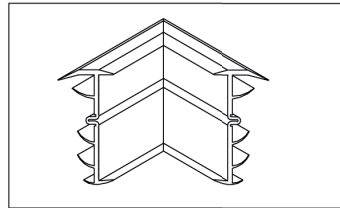
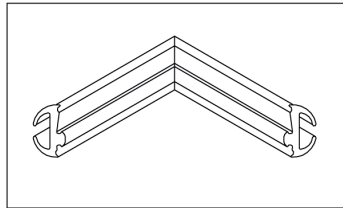
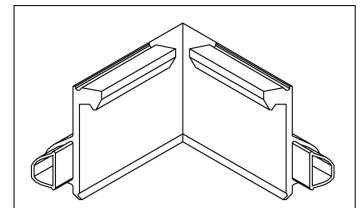
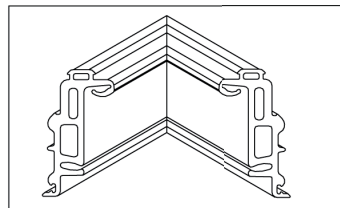
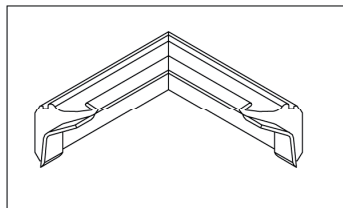
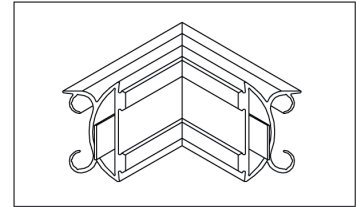
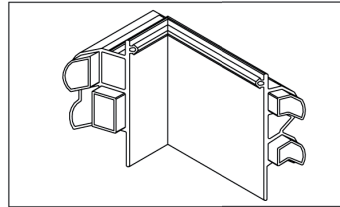
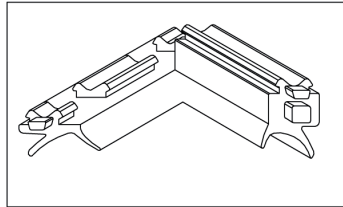
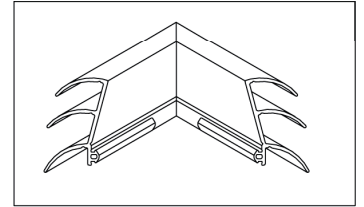
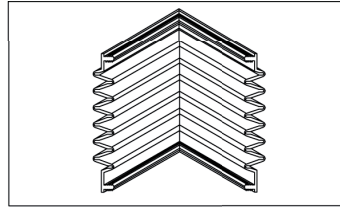
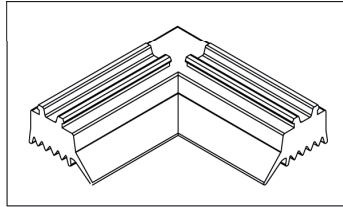

EPDM

Profilecken

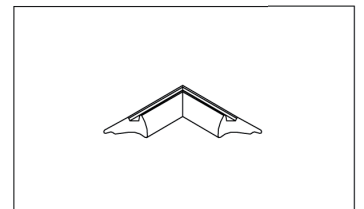
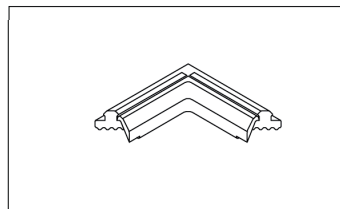
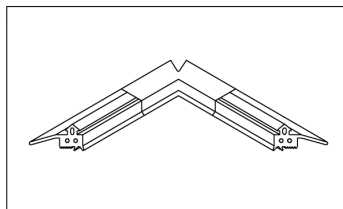
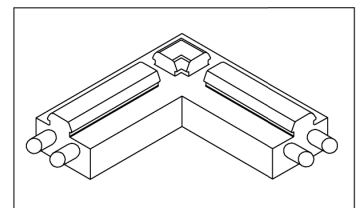
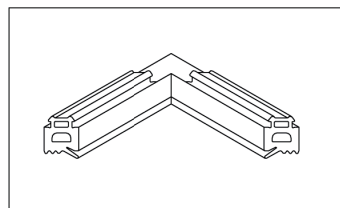
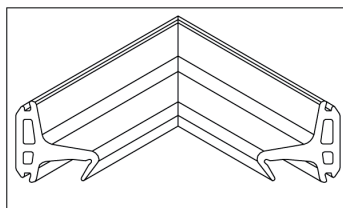
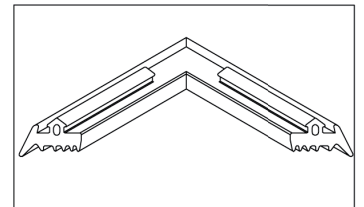
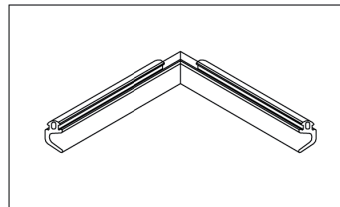
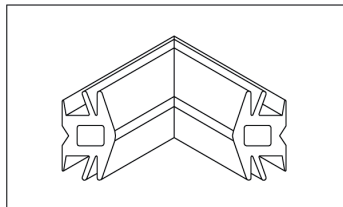
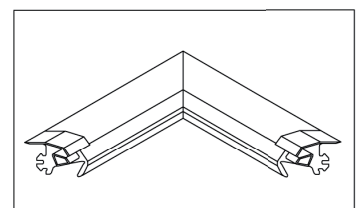
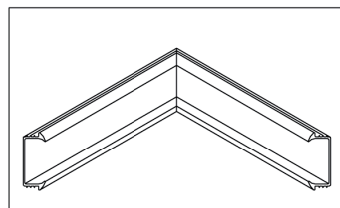
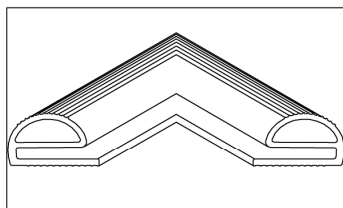
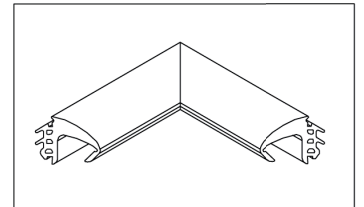
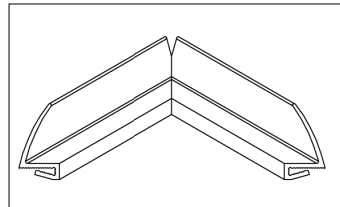
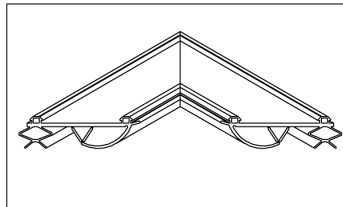
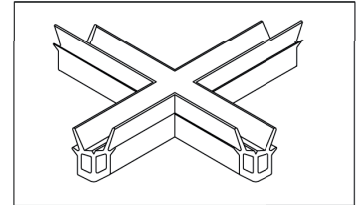
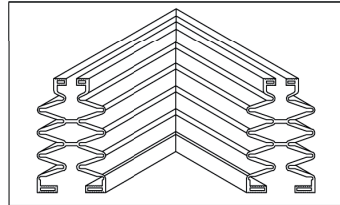
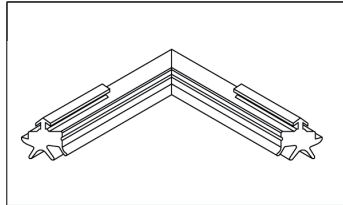

EPDM Profile



Information / Angebot

- Ich interessiere mich für ein bestimmtes Profil.

Art.-Nr.: _____

- Bitte senden Sie mir ein Angebot zu.

Menge: _____

- Bitte nehmen Sie für ein kostenloses Beratungsgespräch Kontakt mit mir auf.

Firma: _____

Name: _____

E-Mail: _____



Weitere Informationen zum Thema Profile
finden Sie auf unserer Homepage:

www.kremer-tec.de

KREMER Technology GmbH • Kinzigstraße 9 – Industriegebiet • D-63607 Wächtersbach
Telefon +49 6053 61 61 - 0 • Telefax +49 6053 97 39 info@kremer-tec.de
• www.kremer-tec.de

